

CHARLOTTE COUNTY BOARD OF COUNTY COMMISSIONERS

ORGANIZATIONAL CHARTS

ADOPTED AS OF OCTOBER 1, 2011

Charlotte County Government Staff Organizational Chart.....1

Administration.....2

Budget and Administrative Services Department.....3

Charlotte County Utilities.....4

Community Development.....5

Community Services.....6

Facilities Construction and Management.....7

Human Resources.....8

Human Services.....9

Metropolitan Planning Organization.....10

Public Safety.....11

Public Works.....12

Tourist Development.....13



Charlotte County Government
Board of County Commissioners
Staff Organization Chart

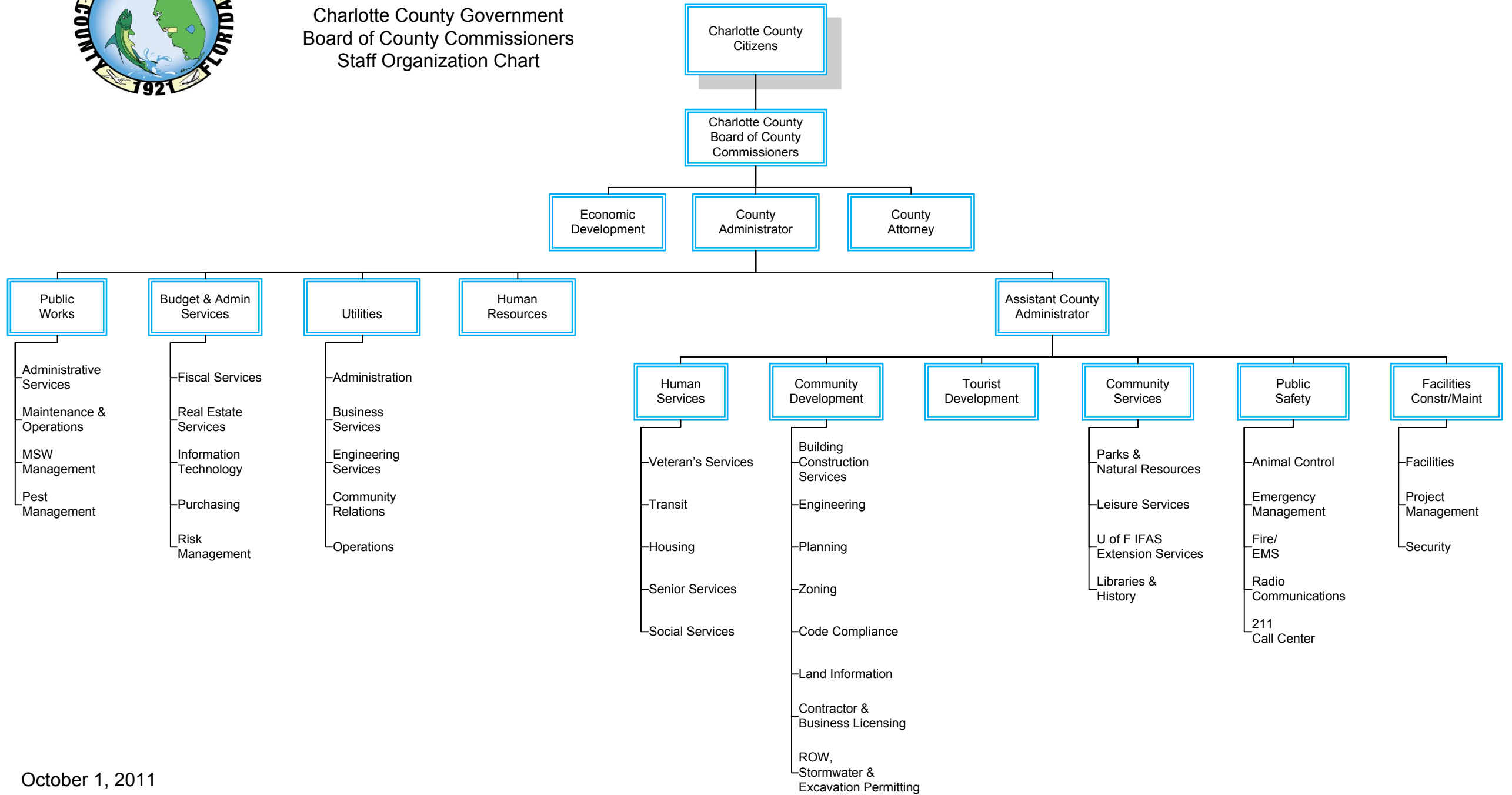

October 1, 2011

Administration

October 1, 2011

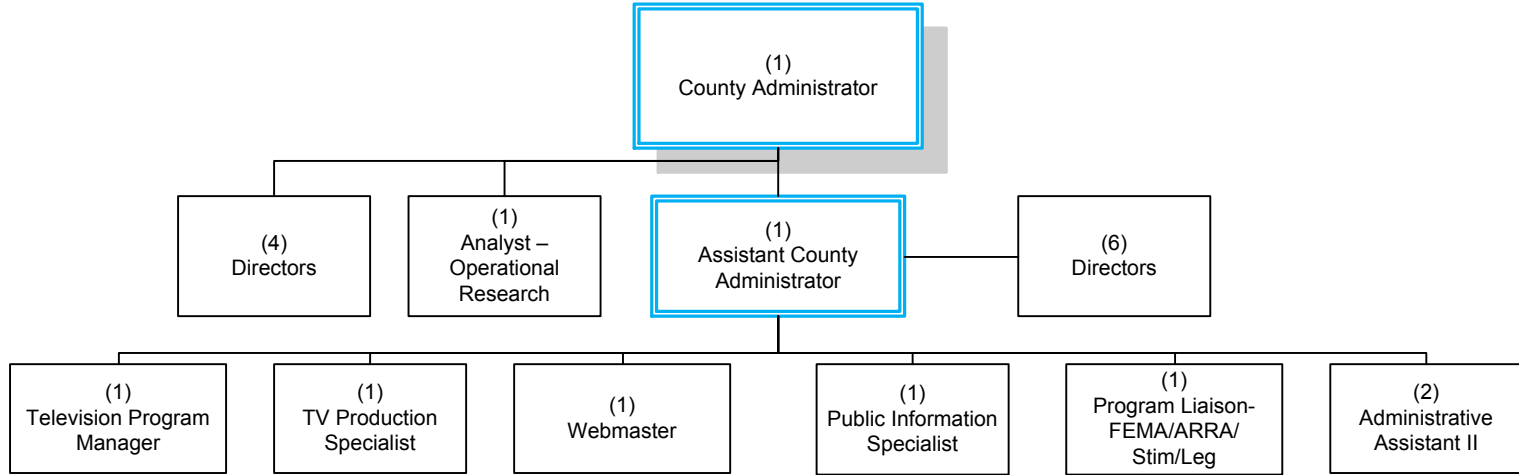

Budget and Administrative Services Department

October 1, 2011

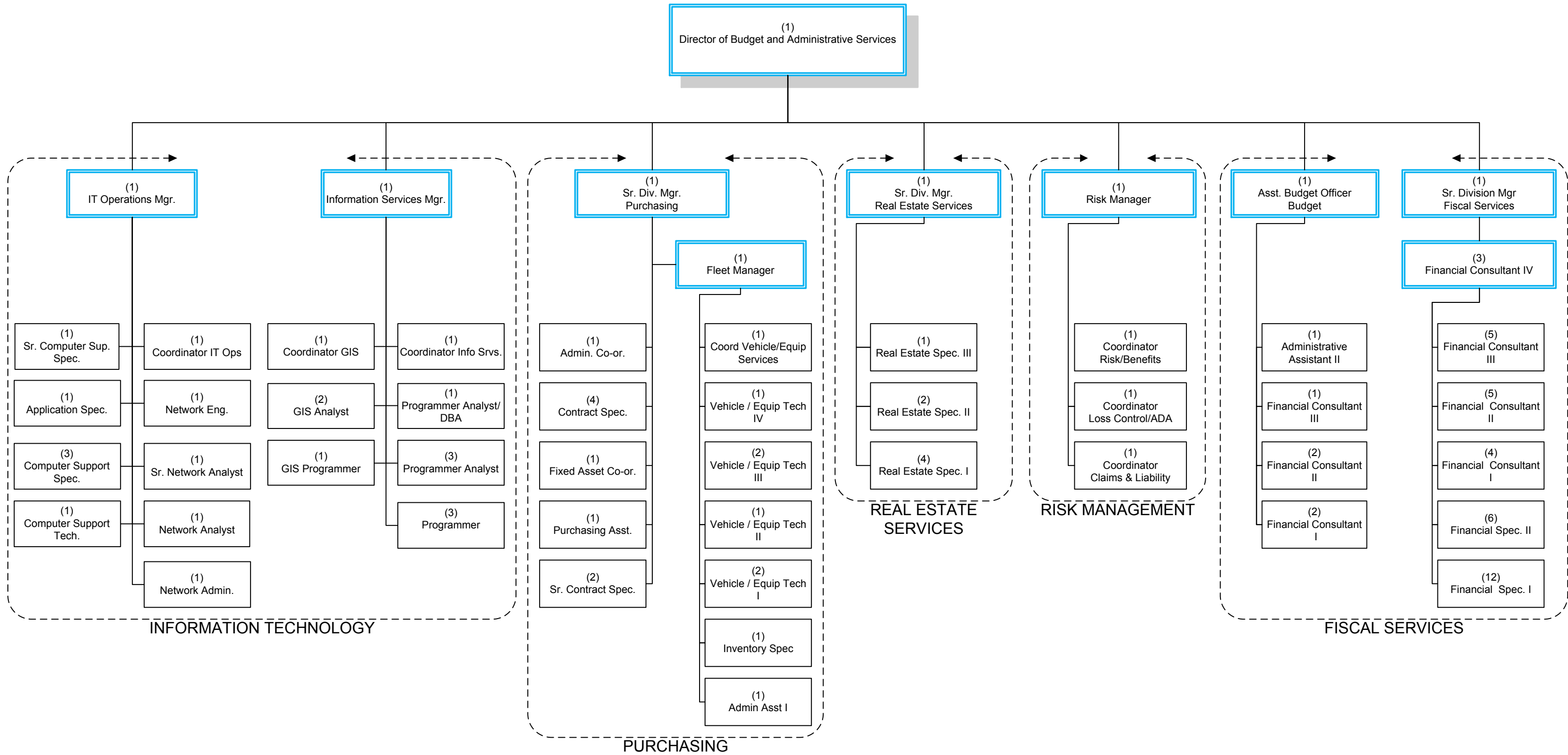

Charlotte County Utilities

October 1, 2011

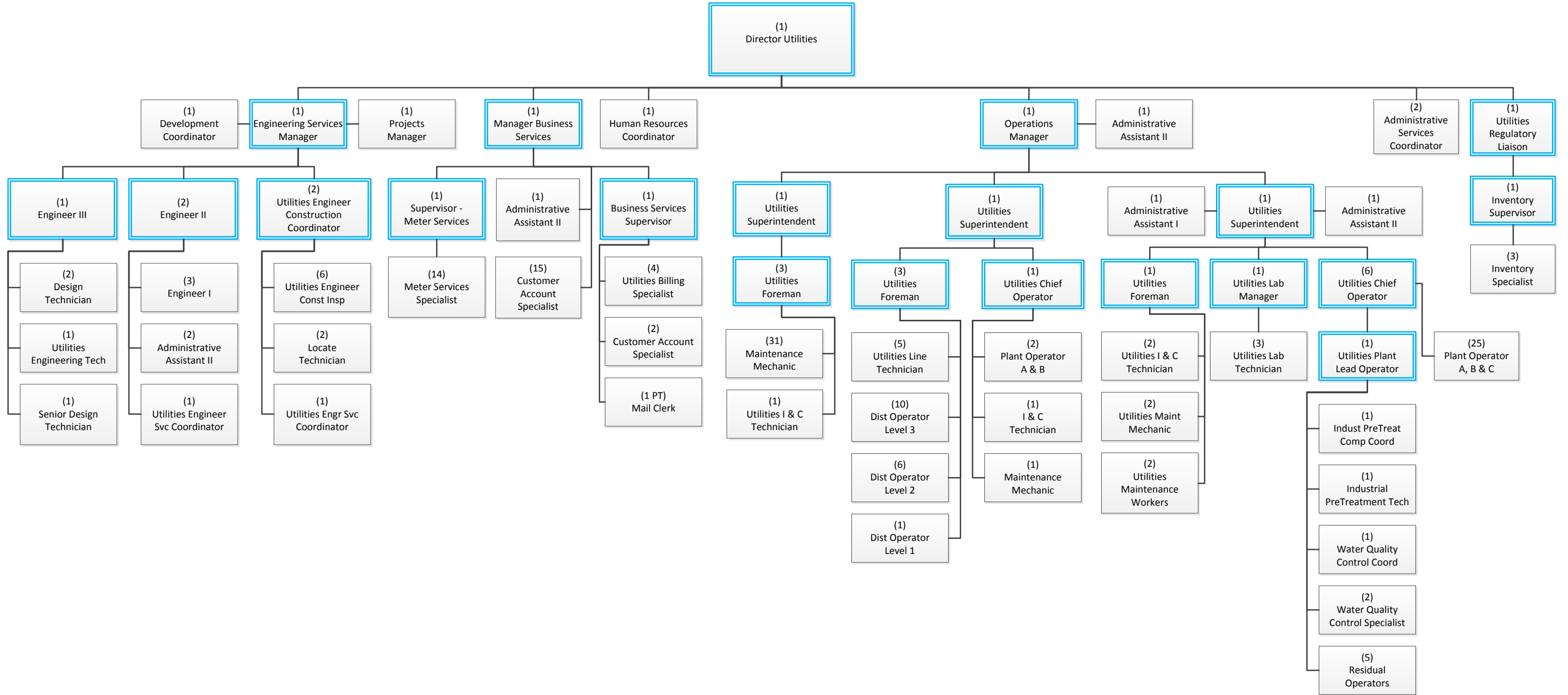

Community Development

October 1, 2011

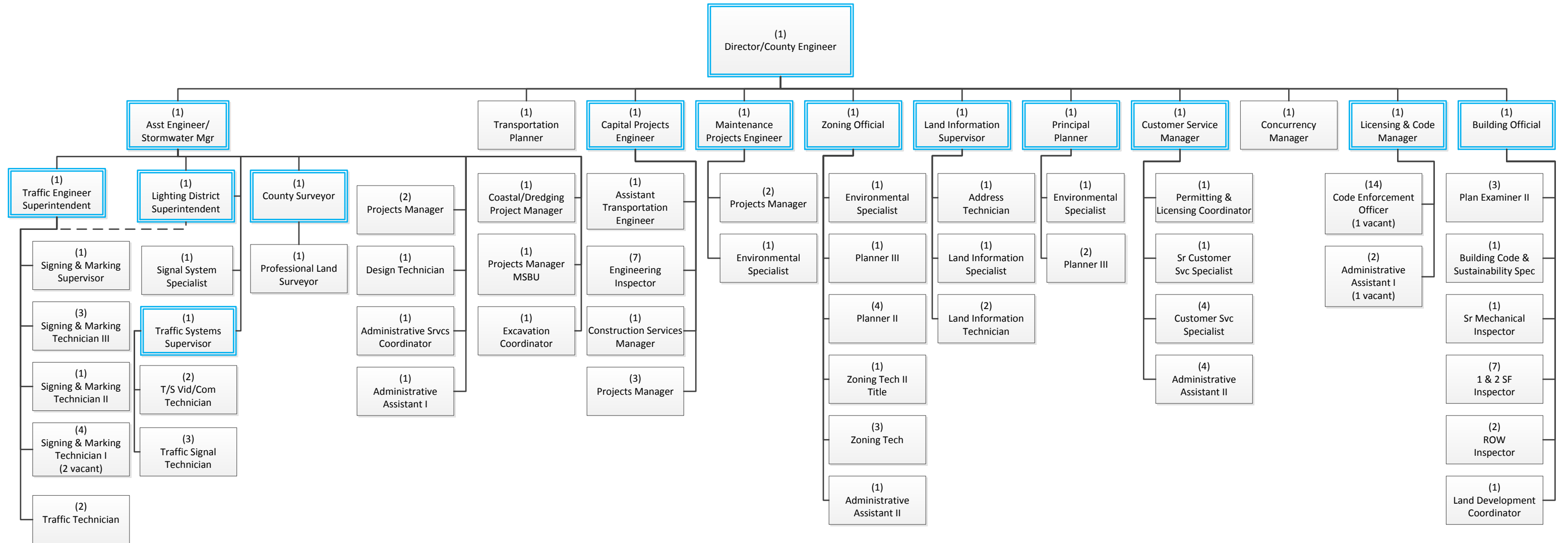

Community Services

October 1, 2011

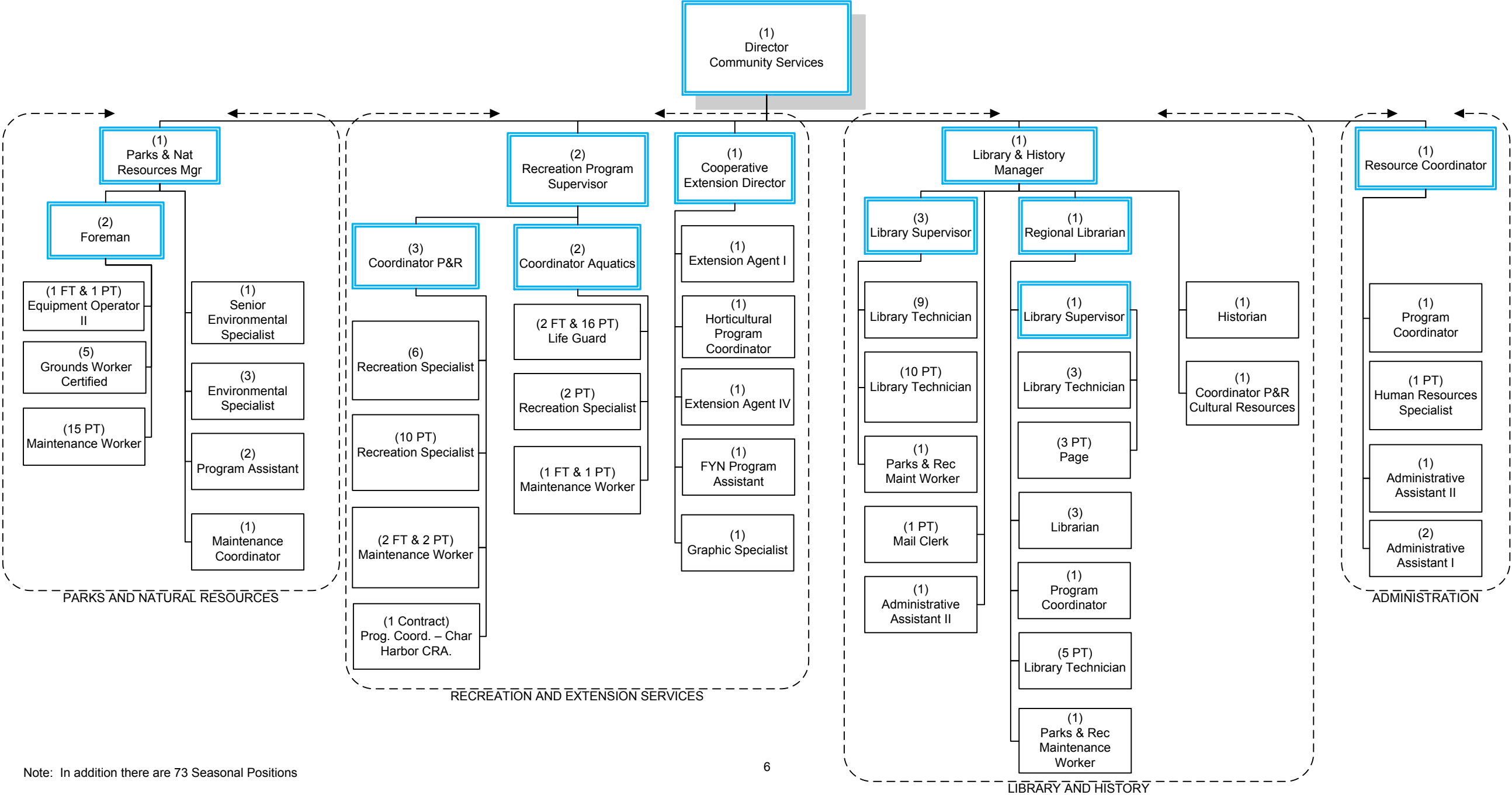

Note: In addition there are 73 Seasonal Positions

Facilities Construction and Management

October 1, 2011

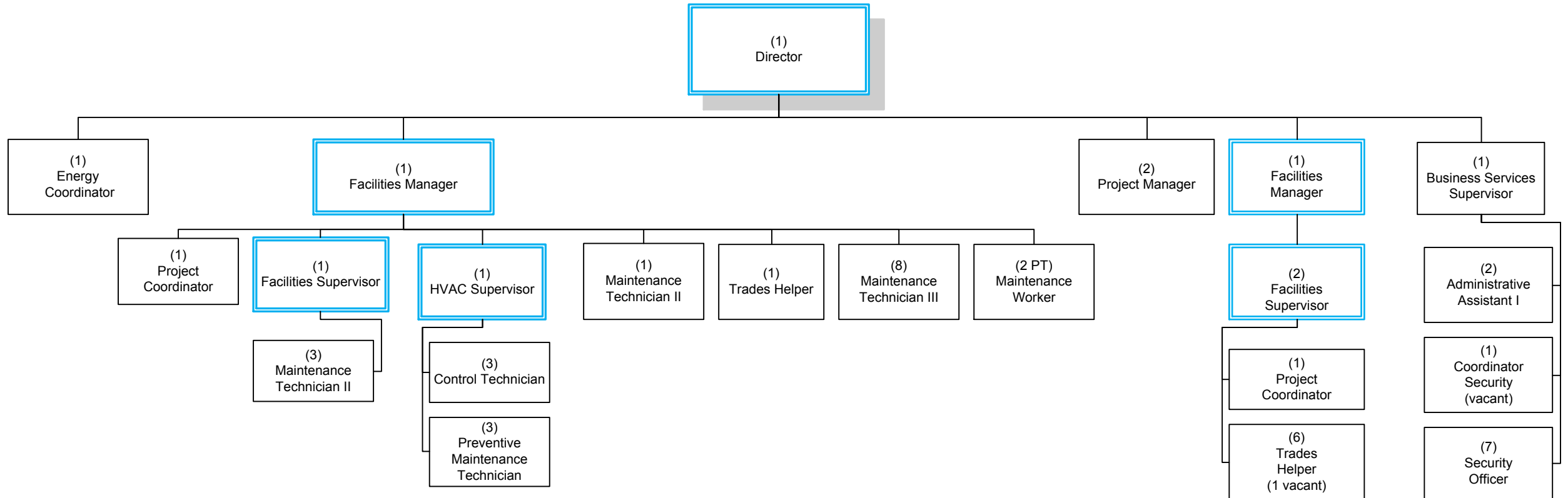

Human Resources

October 1, 2011

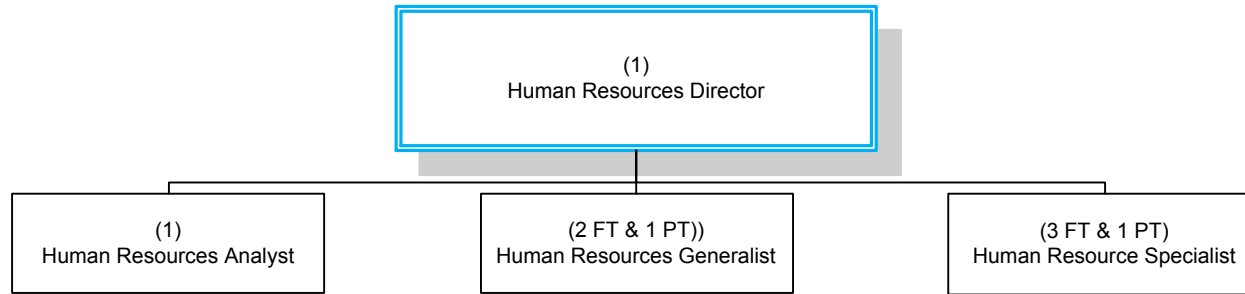

Human Services

October 1, 2011

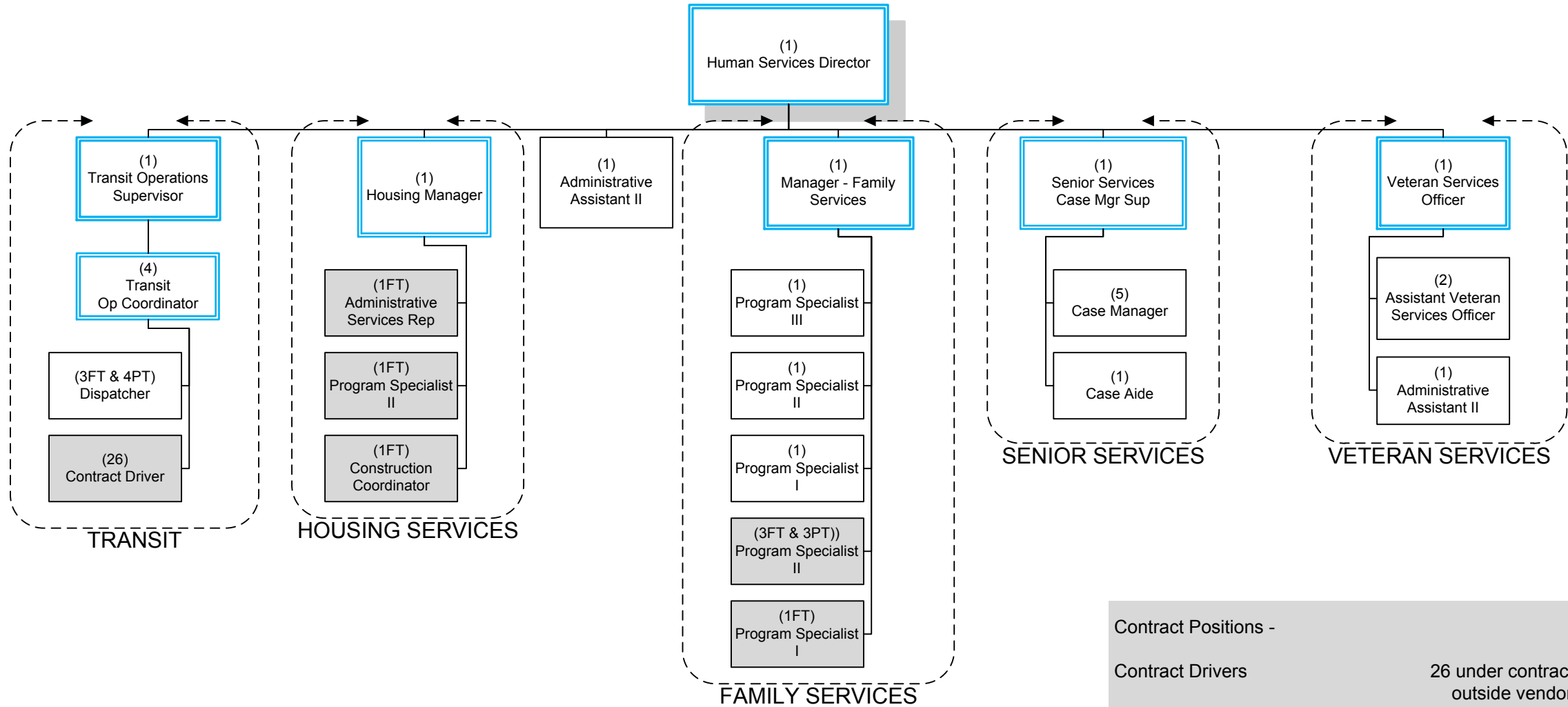

Contract Positions -	
Contract Drivers	26 under contract with outside vendor
Administrative Services Representative	1 Full Time
Construction Coordinator	1 Full Time
Program Specialist II	4 Full Time
Program Specialist II	3 Part Time
Program Specialist I	1 Full Time

Metropolitan Planning Organization

October 1, 2011

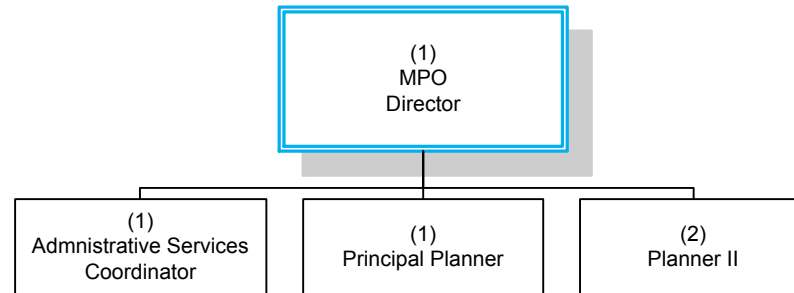

Public Safety

October 1, 2011

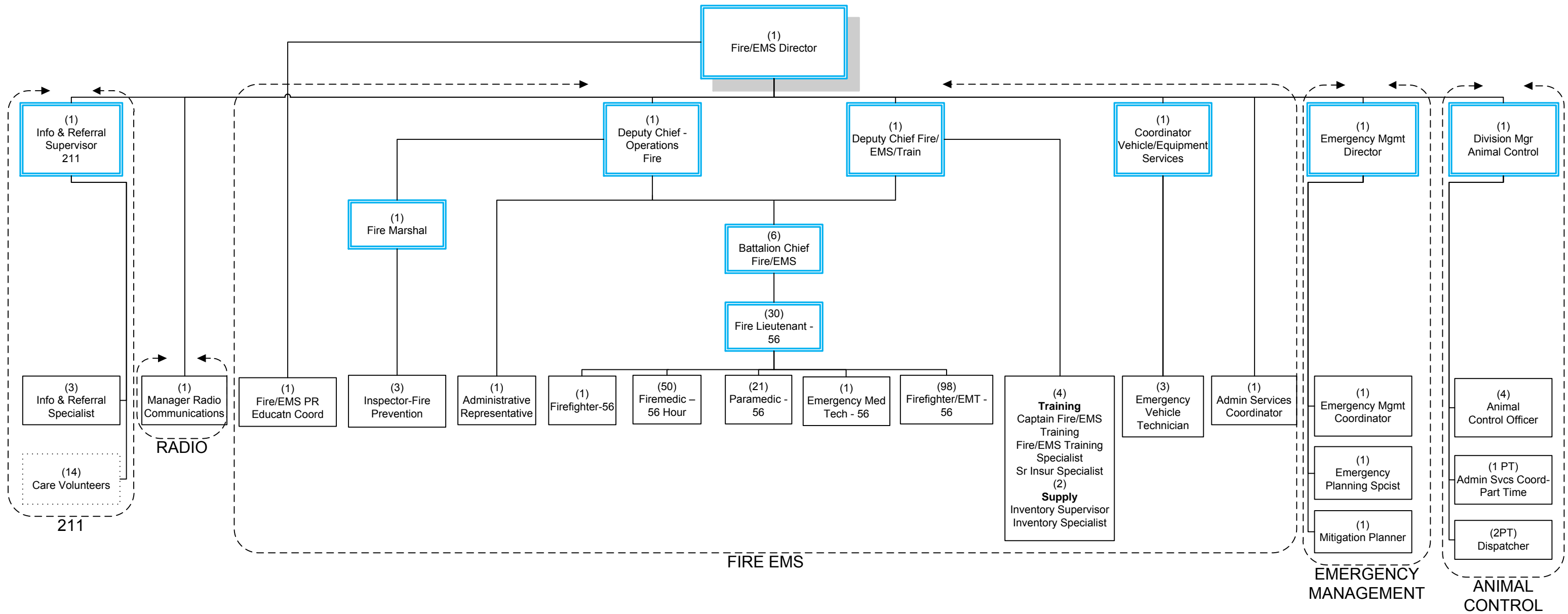

Public Works

October 1, 2011

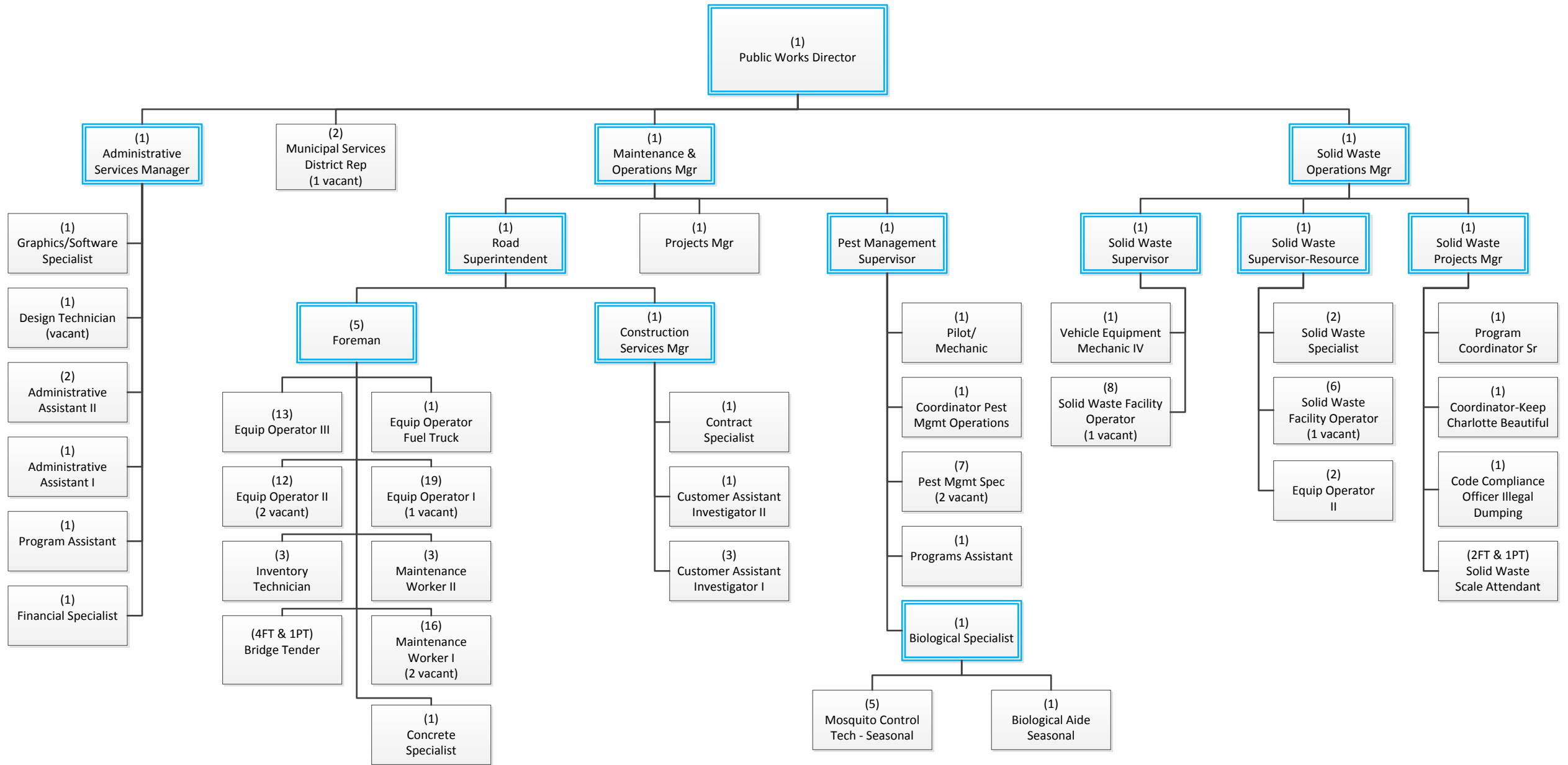

Tourist Development

October 1, 2011

